

Reservdelskatalog
Parts catalogue



SM 460

Grupp R 1
Group

Sida 2
Page

Hydraulsystem

Hydraulic System

Pos. Fig.	Det.nr Part No.	Antal Qty	Benämning	Description	Anmärkning Notes
1	6621476	1	Bränsle- och hydraultank	Fuel and oil tank	Se R 2, See R 2
2	6621477	1	Hydraultank, komplett	Hydraulic oil tank, complete	Se R 2, See R 2
3	6621359	1	Hydraulpump	Hydraulic pump	Se R 3, See R 3
4	6619621	1	Manöverventil	Control valve	Se R 4, See R 4
5	6621445	1	Tryckregleringsventil	Pressure regulating valve	
6	755981	4	Pendel- och styrcylinder	Hydraulic pendulum cylinder	Se J 3, See J 3
7	755997	2	Bandsträckningscylinder	Hydraulic track-stretching cylinder	Se J 2, See J 2
8	C 1713	1	Stödcylinder	Supporting cylinder	Se U 19, See U 19
9	6619609	*	Slang	Hose	
10	6619607	*	Slang	Hose	
11	6621493	4	Slangklamma	Hose clip	
12	951789	2	Slangklamma	Hose clip	
13	6600612	1	Vinkel, 45°	Pipe elbow, 45°	
14	6621496	1	Slanganslutning	Hose connection	
15	6619607	*	Slang	Hose	
16	6619608	1	Slang	Hose	
17	6621464	1	Rör	Pipe	
18	6617888	-3	T-koppling, komplett	T-shaped threaded union	Se R 5, See R 5
19	6619605	1	Slang	Hose	
20	6621494	1	Vinkelnippel	Angular union	
21	6619617	2	Slang	Hose	
22	6617897	4	Vinkelnippel	Angular union	
23	6621468	1	Rör	Pipe	
24	6621467	1	Rör	Pipe	
25	6621495	2	Reducering, komplett	Reducing bush, complete	Se R 5, See R 5
26	755161	2	Nippel	Threaded union	
27	755951	5	Ventil	Valve	
28	6606367	6	Koppling, rak	Threaded union, straight	Se R 5, See R 5
29	6621462	1	Rör	Pipe	
30	6621463	1	Rör	Pipe	
31	6606439	13	Vinkelkoppling	Angular union	Se R 5, See R 5
32	755848	4	Rör	Pipe	
33	6619604	4	Slang	Hose	
34	6621471	1	Rör	Pipe	
35	6621469	1	Rör	Pipe	
36	6617886	1	Skarvkoppling	Threaded connector	Se R 5, See R 5
37	6621470	1	Rör	Pipe	
38	6619606	4	Slang	Hose	
39	755847	4	Svivel, komplett	Swivel, complete	
40	925058	4	O-ring	O-ring	
41	6617883	2	Nippel	Threaded union	
42	6619622	1	Rör	Pipe	

* Säljes endast i hela meter.
Sold only in whole meters.
Se vende sólo por metros.
Vendu seulement au mètres.
Wird nur in ganzen Metern verkauft.

SM 460

Hydraulsystem

Hydraulic System



Reservdelskatalog
Parts catalogue

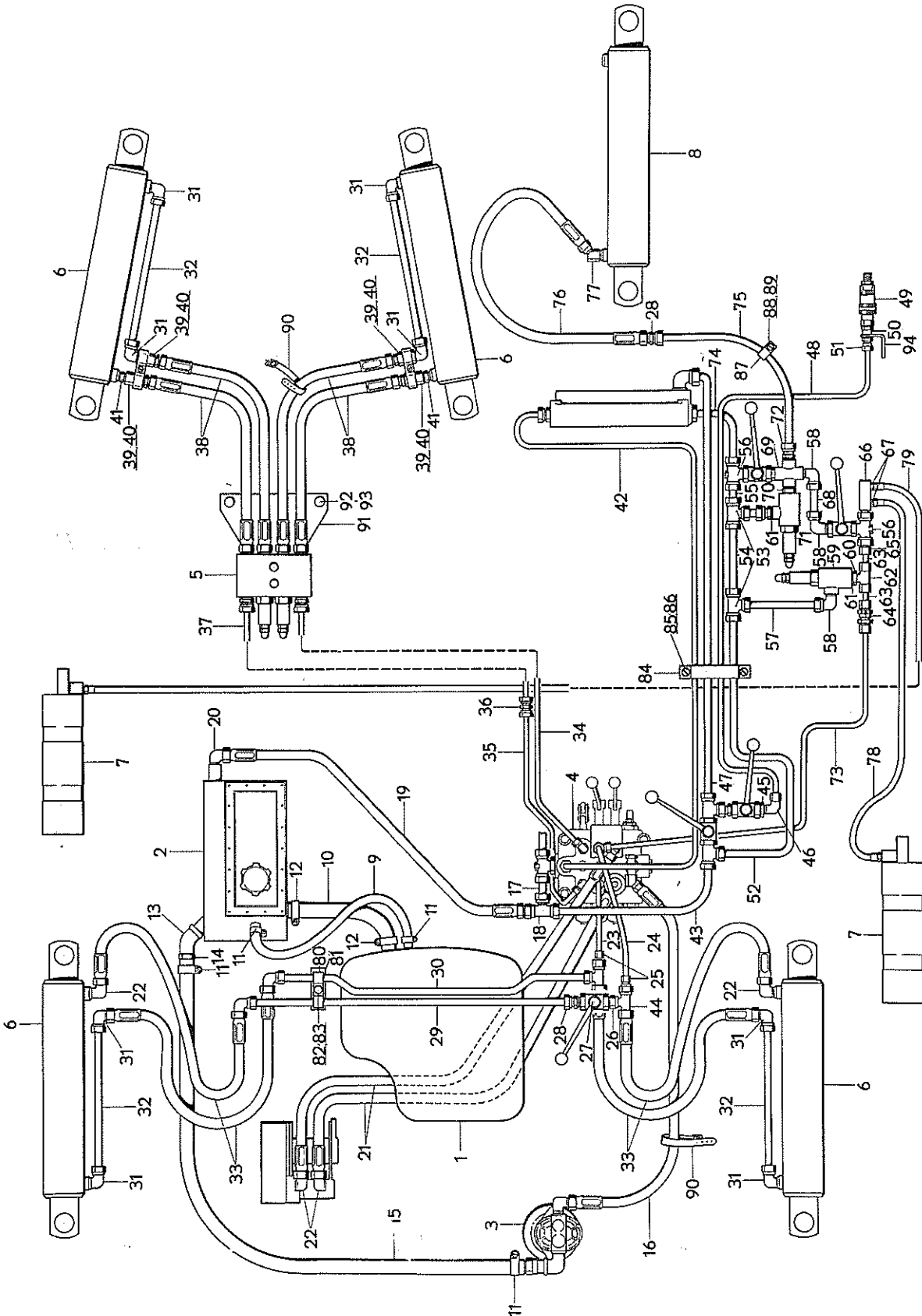

Reservdelskatalog
Parts catalogue



SM 460

Hydraulsystem

Hydraulic System

Grupp R 1
Group

Sida 4
Page

Pos. Fig.	Det.nr Part No.	Antal Qty	Benämning	Description	Anmärkning Notes
43	6621484	1	Rör	Pipe	
44	6617888	2	T-koppling, komplett	T-shaped threaded union, compl.	Se R 5, See R 5
45	6600610	1	Reduceringsnippel	Reducing union	
46	6621498	1	Vinkelkoppling, komplett	Angular union, complete	Se R 5, See R 5
47	6619623	1	Rör	Pipe	
48	6621474	1	Rör	Pipe	
49	755954	1	Snabbkoppling, komplett	Quick coupling, complete	Se R 5, See R 5
50	6621492	1	Nippel	Threaded union	Se R 5, See R 5
51	6606365	1	Koppling, rak	Threaded union, straight	Se R 5, See R 5
52	6619624	1	Rör	Pipe	
53	6617893	2	T-koppling	T-shaped threaded union	Se R 5, See R 5
54	6619625	1	Rör	Pipe	
55	6619626	1	Rör	Pipe	
56	6606515	2	T-koppling	T-shaped threaded union	Se R 5, See R 5
57	6619627	1	Rör	Pipe	
58	6606439	3	Vinkelkoppling	Angular union	Se R 5, See R 5
59	755953	1	Överströmningsventil	Overflow valve	
60	6619635	1	Reduceringsnippel	Reducing union	
61	907135	2	Bricka	Washer	
62	6606513	1	T-koppling	T-shaped threaded union	Se R 5, See R 5
63	6621482	2	Rör	Pipe	
64	6621497	1	Backventil	Check valve	
65	6617887	1	Reducering	Reducing bush	
66	755825	1	Anslutning	Connection	
67	6617884	2	Nippel	Threaded union	
68	6619629	1	Rör	Pipe	
69	6619636	1	Korsrör	Pipe cross	
70	6617883	2	Nippel	Threaded union	
71	755953	1	Överströmningsventil	Overflow valve	
72	6606367	2	Koppling, rak	Threaded union, straight	Se R 5, See R 5
73	6619630	1	Rör	Pipe	
74	6619631	1	Rör	Pipe	
75	6619632	1	Rör	Pipe	
76	6619618	1	Slang	Hose	
77	6619637	1	Nippel	Threaded union	
78	755814	1	Hydraulslang	Hydraulic line	
79	755826	1	Hydraulslang	Hydraulic line	
80	6621345	4	Klamma	Clamp	
81	6621461	1	Underlägg	Backing washer	
82	955536	3	Skruv	Bolt	
83	950364	3	Mutter	Nut	
84	6619638	1	Klamma	Clamp	
85	955523	2	Skruv	Bolt	

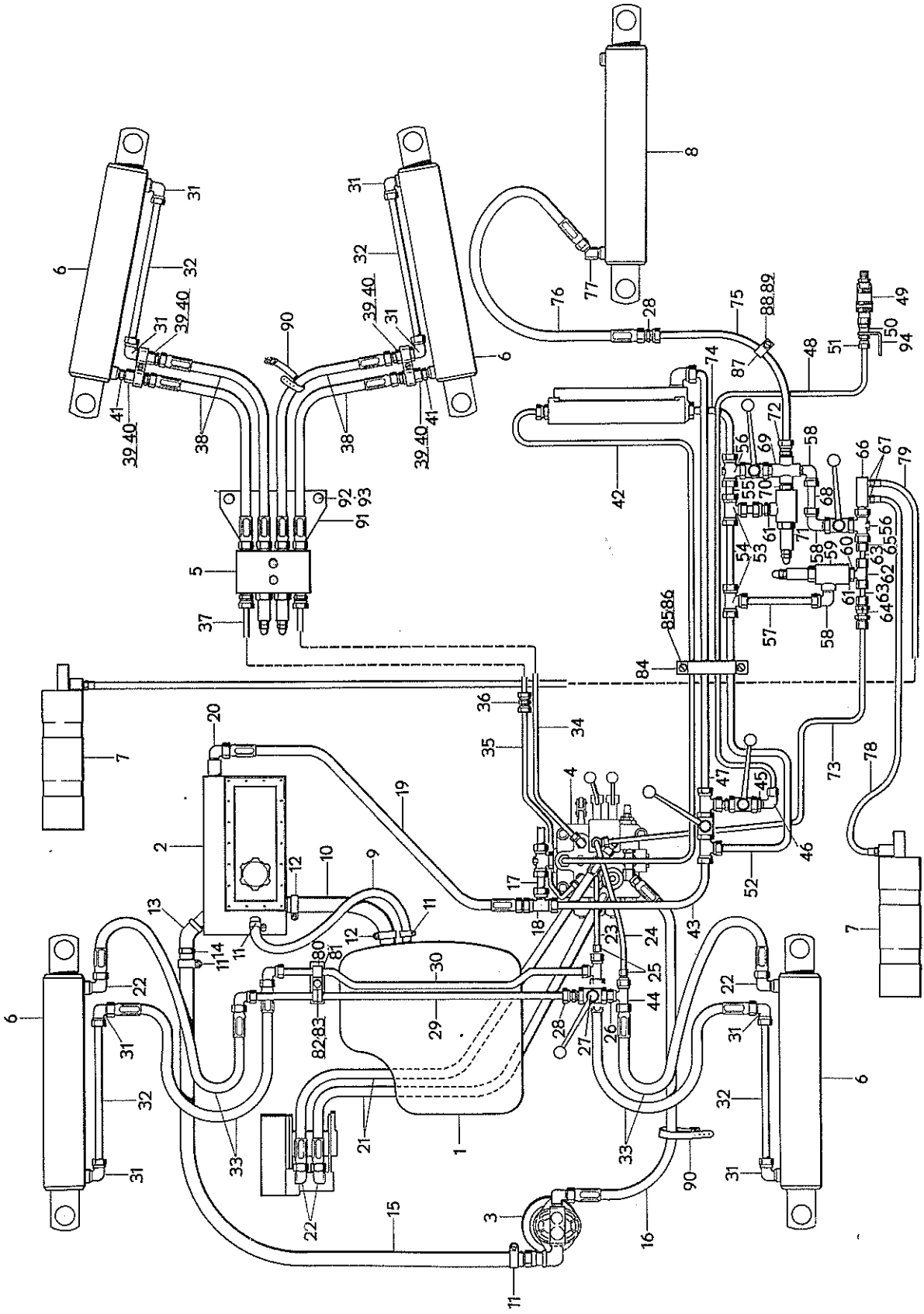

Reservdelskatalog
Parts catalogue



SM 460

Grupp R 1
Group

Sida 6
Page

Hydraulsystem

Hydraulic System

Pos. Fig.	Def.nr Part No.	Aniäl Qty	Benämning	Description	Anmärkning Notes
86	955921	2	Fjäderbricka	Spring washer	
87	6619639	1	Klamma	Clamp	
88	921804	1	Skruv	Bolt	
89	955920	1	Fjäderbricka	Spring washer	
90	6621453	2	Läderrem	Leather strap	
91	6621472	1	Konsol för tryckreglerings- ventil	Bracket for pressure regulating valve	
92	924303	2	Skruv	Bolt	
93	921849	2	Skruv	Bolt	
94	6621441	1	Fästvinkel	Mounting angle	

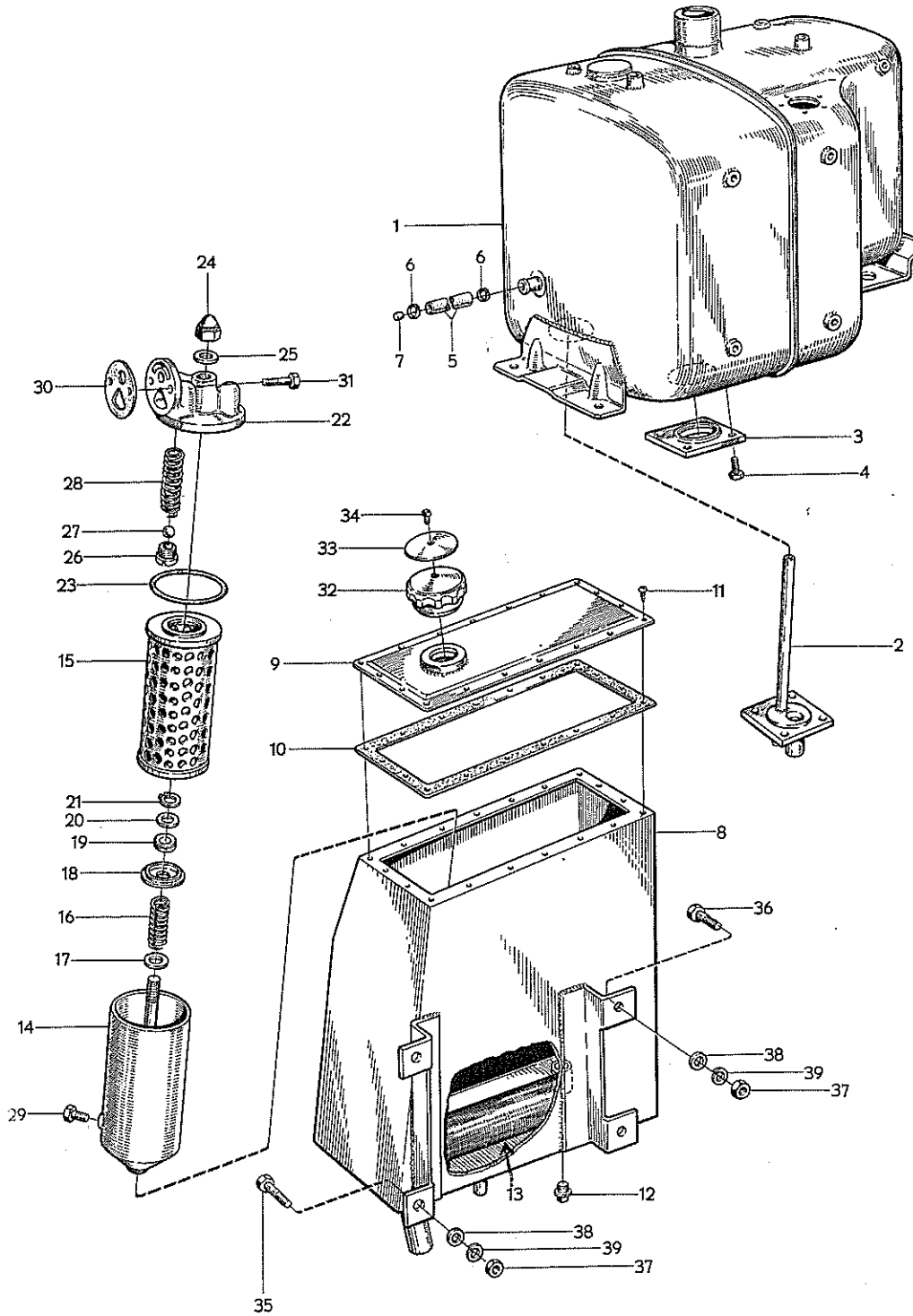

Reservdelskatalog
Paris catalogue



SM 460

Grupp R 2
Group

Sida 2
Page

Hydraultank med filter Hydraulic Oil Tank with Filter

Pos. Fig.	Det.nr Part No.	Antal Qty	Benämning	Description	Anmärkning Notes
1	6621476	1	Bränsle- och oljetank	Fuel and oil tank	
2	6621465	1	Slanganslutning	Hose connection	
3	6621466	1	Lock	Cover	
4	955522	8	Skruv	Bolt	
5	6619610	1	Slang	Hose	
6	7079861	2	Slangklamma	Hose clip	
7	755484	1	Propp	Plug	
8	6621477	1	Hydraultank, komplett	Hydraulic oil tank, complete	
9	6621459	1	. Lock Tank cover	
10	6621460	1	. Packning	. Gasket	
11	6621456	18	. Skruv	. Bolt	
12	6600604	1	. Propp	. Plug	
13	6621478	1	. Sugsil Suction strainer	
	6603025	1	. Filter, komplett	. Oil filter, complete	
14	6605088	1	. . Behållare	. . Filter housing	
15	6603379	1	. . Insats	. . Filter element	
16	6606748	1	. . Fjäder Spring	
17	6606749	1	. . Bricka	. . Washer	
18	6606747	1	. . Bricka	. . Washer	
19	6606750	1	. . Tätning	. . Seal	
20	6609350	1	. . Bricka Washer	
21	914449	1	. . Spårring	. . Circlip	
22	6605089	1	. . Lock	. . Filter cover	
23	6604384	1	. . Packning	. . Gasket	
24	6609351	1	. . Mutter Nut	
25	6604388	1	. . Packning	. . Gasket	
26	6605091	1	. . Ventilsåte	. . Valve seat	
27	7000205	1	. . Kula	. . Ball	
28	6609352	1	. . Fjäder Spring	
29	6605092	1	. . Propp	. . Plug	
30	775661	1	. Packning	. Gasket	
31	921846	2	. Skruv	. Bolt	
32	719617	1	. Påfyllningslock Filler cap	
33	719618	1	. Skylt	. Sign plate	
34	955119	1	. Skruv	. Bolt	
35	921808	2	. Skruv	. Bolt	
36	955524	2	. Skruv Bolt	
37	955826	4	. Mutter	. Nut	
38	960141	4	. Bricka	. Washer	
39	955921	4	. Fjäderbricka	. Spring washer	

Grupp R 3 Group	SM 460		Reservdelskatalog Parts catalogue
Sida 1 Page			

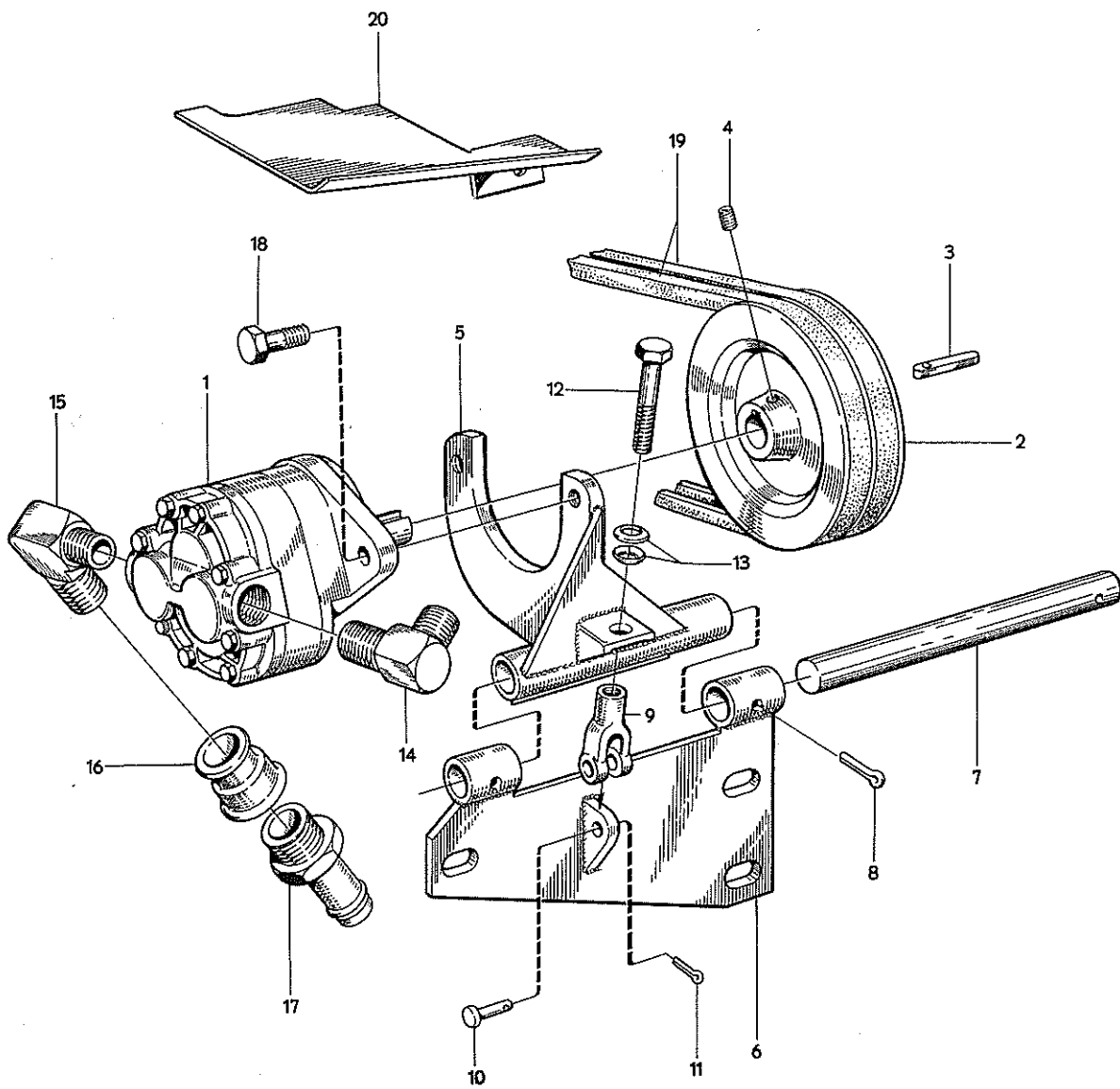



Hydraulpump

Hydraulic Pump

Pos. Fig.	Def.nr Part No.	Antal Qty	Benämning	Description	Anmärkning Notes
1	6621359	1	Hydraulpump, komplett	Hydraulic oil pump, complete . .	
2	6621356	1	Remskiva	V-belt pulley	
3	6621357	1	Kil	Key	
4	6621368	1	Stoppskruv	Set screw	
	6621353	1	Pumpkonsol, komplett	Pump bracket, complete	
5	6619640	1	. Konsol	. Pump bracket	
6	6619641	1	. Fäste	. Mounting	
7	6621354	1	. Axel	. Shaft	
8	907871	1	. Saxpinne Cotter pin	
9	728413	1	. Gaffel	. Joint fork	
10	913113	1	. Länkbult	. Clevis pin	
11	907821	1	. Saxpinne	. Cotter pin	
12	921629	1	. Skruv Bolt	
13	6621355	2	. Brickfjäder	. Cup washer	
14	6617899	1	Vinkelnippel	Angular union	
15	6621494	1	Vinkelnippel	Angular union	
16	6600613	1	Förminskning	Reducing union	
17	6621496	1	Slanganslutning	Hose connection	
18	921858	2	Skruv	Bolt	
19	958305	1	Kilrem	V-belt	sats, set
20	6621358	1	Skyddsplåt	Guard plate	

SM 460

Manöverventil

Control Valve



Reservdelskatalog
Parts catalogue

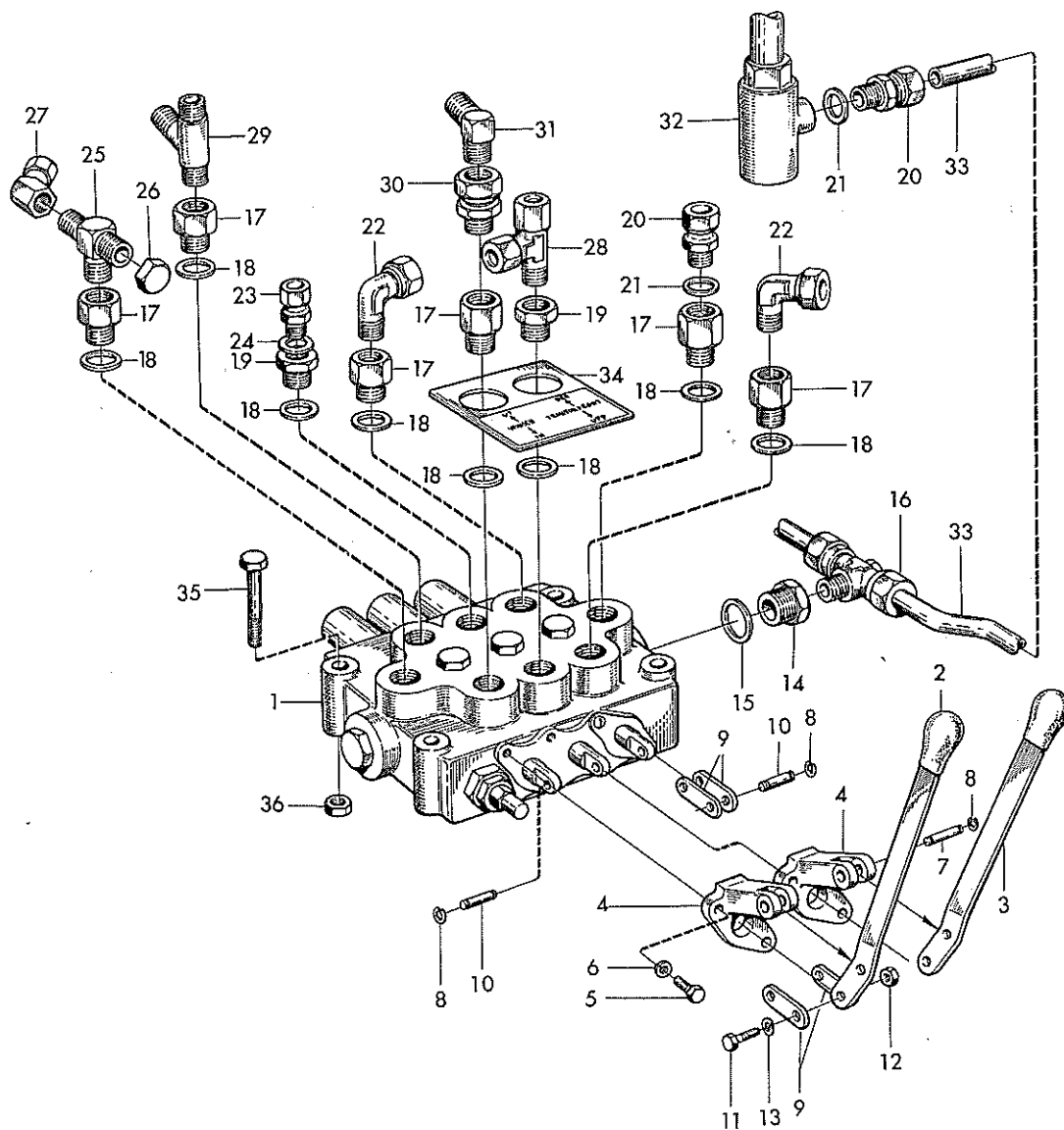

Reservdelskatalog
Parts catalogue



SM 460

Grupp
Group R 4

Sida
Page 2

Manöverventil

Control Valve

Pos. Fig.	Det.nr Part No.	Antal Qty	Benämning	Description	Anmärkning Notes
	6621369	1	Manöverventil, komplett	Control valve, complete	
1	755928	1	. Manöverventil	. Control valve	
2	6621370	1	. Spak	. Operating lever	
3	6619642	1	. Spak	. Operating lever	
4	755931	2	. Fäste Lever mounting	
5	921807	4	. Skruv	. Bolt	
6	955920	4	. Fjäderbricka	. Spring washer	
7	755932	2	. Cyl. pinne	. Cylindrical pin	
8	755933	16	. Spårring Circlip	
9	755935	8	. Länk	. Link	
10	755936	6	. Cyl. pinne	. Cylindrical pin	
11	921626	2	. Skruv	. Bolt	
12	950383	2	. Mutter Nut	
13	955934	2	. Fjäderbricka	. Spring washer	
14	6621501	1	. Reducering	. Reducing union	
15	907139	1	. Packning	. Gasket	
16	6606515	1	. T-koppling, komplett T-shaped threaded union, complete	Se R 5, See R 5
17	6617891	6	. Reducering	. Reducing union	
18	907137	8	. Packning	. Gasket	
19	6617193	2	. Reducering	. Reducing union	
20	6606367	2	. Koppling, komplett Threaded union, complete ..	Se R 5, See R 5
21	907135	2	. Packning	. Gasket	
22	755267	2	. Vinkelkoppling, komplett	. Threaded elbow union, compl.	Se R 5, See R 5
23	6606365	1	. Koppling, komplett	. Threaded union, complete	Se R 5, See R 5
24	907134	2	. Packning Gasket	
25	6621499	1	. T-nippel	. T-shaped threaded union	
26	755817	1	. Huv	. Hood	
27	6621500	1	. Koppling, komplett	. Threaded union, complete	Se R 5, See R 5
28	6619645	1	. T-koppling, komplett T-shaped threaded union, complete	Se R 5, See R 5
29	6619646	1	. T-nippel	. T-shaped threaded union	
30	6619647	1	. Koppling, komplett	. Threaded union, complete	
31	6617899	1	. Vinkelnippel	. Angular union	
32	755953	1	. Överströmningsventil Overflow valve	
33	6619648	1	. Rör	. Pipe	
34	755964	1	. Skylt	. Sign plate	
35	955542	3	. Skruv	. Bolt	
36	6621443	3	. Mutter Nut	

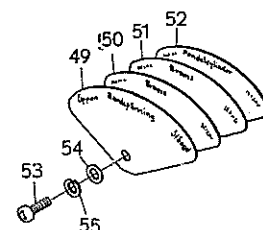
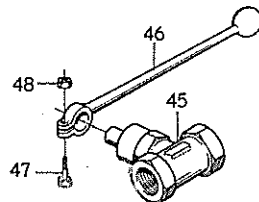
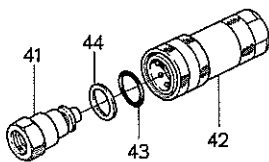
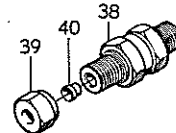
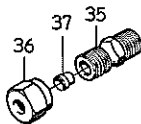
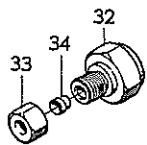
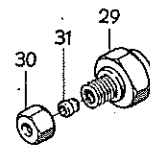
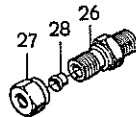
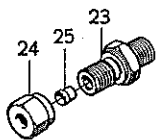
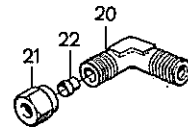
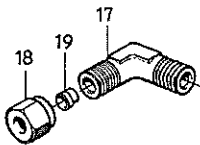
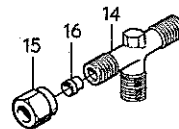
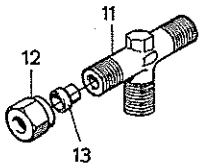
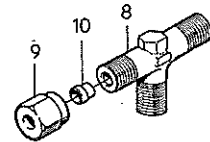
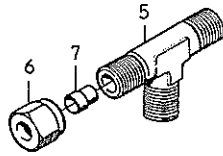
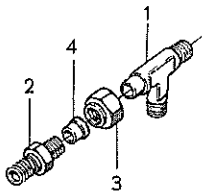

Reservdelskatalog
Parts catalogue



SM 460

Grupp
Group R 5

Sida
Page 2

Rörkopplingar och ventiler Threaded Unions and Valves

Pos. Fig.	Def.nr Part No.	Antal Qty	Beskrivning	Description	Anmärkning Notes
1	6619645	1	T-koppling, komplett	T-shaped threaded union, compl.	
2	957042		. Nippel	. Threaded union	
3	956984	3	. Mutter	. Nut	
4	956970	3	. Skärring	. Sealing cone	
5	6617888	1	T-koppling, komplett	T-shaped threaded union, compl.	
6	956986	2	. Mutter	. Nut	
7	956972	2	. Skärring	. Sealing cone	
8	6606515	1	T-koppling, komplett	T-shaped threaded union, compl.	
9	956984	2	. Mutter Nut	
10	956972	2	. Skärring	. Sealing cone	
11	6606513	1	T-koppling, komplett	T-shaped threaded union, compl.	
12	956984	2	. Mutter	. Nut	
13	956970	2	. Skärring Sealing cone	
14	6617893	1	T-koppling, komplett	T-shaped threaded union, compl.	
15	956986	3	. Mutter	. Nut	
16	956972	3	. Skärring	. Sealing cone	
17	6606439	1	Vinkelkoppling, komplett	Threaded elbow union, complete .	
18	956984	1	. Mutter	. Nut	
19	956970	1	. Skärring	. Sealing cone	
20	6606441	1	Vinkelkoppling, komplett	Threaded elbow union, complete	
21	956986	1	. Mutter Nut	
22	956972	1	. Skärring	. Sealing cone	
23	6606365	1	Rak koppling, komplett	Threaded union, straight, compl.	
24	956984	1	. Mutter	. Nut	
25	956970	1	. Skärring Sealing cone	
26	6606367	1	Rak koppling, komplett	Threaded union, straight, compl.	
27	956986	1	. Mutter	. Nut	
28	956972	1	. Skärring	. Sealing cone	
29	6621495	1	Reducering, komplett	Reducing union, complete	
30	956984	1	. Mutter	. Nut	
31	956974	1	. Skärring	. Sealing cone	
32	6617887	1	Reducering, komplett	Reducing union, complete	
33	956986	1	. Mutter Nut	
34	956972	1	. Skärring	. Sealing cone	
35	6617886	1	Skarvkoppling, komplett	Threaded connector, complete	
36	956986	2	. Mutter	. Nut	
37	956972	2	. Skärring Sealing cone	
38	6621497	1	Backventil, komplett	Check valve, complete	
39	956984	1	. Mutter	. Nut	
40	956970	1	. Skärring	. Sealing cone	
	755954	1	Snabbkoppling, komplett	Quick coupling, complete	
41	6621816	1	. Hane	. Male part	

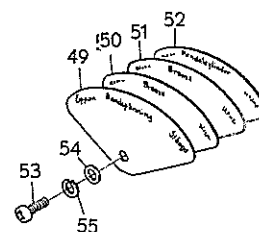
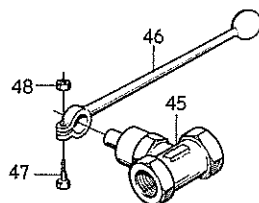
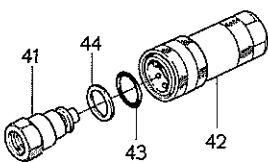
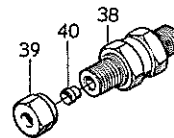
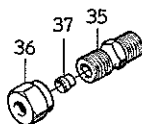
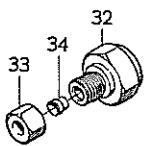
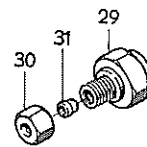
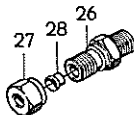
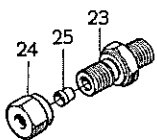
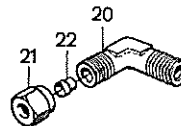
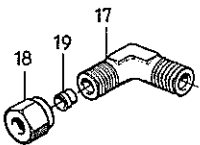
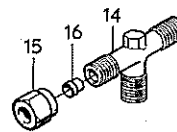
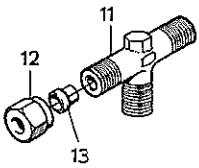
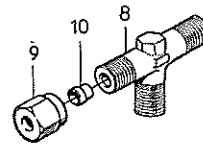
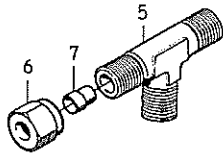
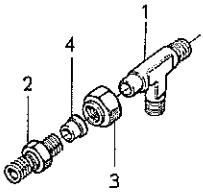

Reservdelskatalog
Parts catalogue



SM 460

Grupp
Group R 5

Sida
Page 4

Rörkopplingar och ventiler Threaded Unions and Valves

Pos. Fig.	Def.nr Part No.	Antal Qty	Benämning	Description	Anmärkning Notes
42	6621815	1	. Hona, komplett Female part, complete	
43	6611880	1	. . O-ring	. . O-ring	
44	6612586	1	. . Stödring	. . Retainer	
	6611462	1	Skyddslock	Protective cover	
	6611463	1	Skyddspropp	Protective plug	
45	755951	1	Avstängningsventil, komplett	Shut-off valve, complete	
46	755867	1	. Spak	. Lever	
47	916357	1	. Skruv	. Bolt	
48	906575	1	. -Mutter Nut	
49	755868	1	Skylt för ventil, bandspänning	Sign plate for valve, track tension	
50	755896	1	Skylt för ventil, broms	Sign plate for valve, brake	
51	755870	1	Skylt för ventil, broms	Sign plate for valve, brake	
52	6621481	1	Skylt för ventil, pendelcylinder.	Sign plate for valve, pendulum cylinder	
53	925665	4	Skruv	Bolt	
54	955892	4	Bricka	Washer	
55	955919	4	Fjäderbricka	Spring washer	

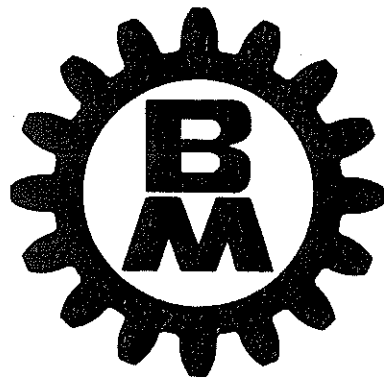

VOLVO

Reservdelskatalog
Parts catalogue



SM 460

Grupp
Group S 1

Sida
Page 1

Verktyg

Tools

Pos. Fig.	Det.nr Part No.	Antal Qty	Benämning	Description	Anmärkning Notes
	736392	1	Verktygspåse	Tool bag	
	9820740	1	Skruvmejsel	Screw driver	
	7000872	1	Skiftnyckel	Adjustable wrench	
	705544	1	Hylsnyckel	Socket wrench	
	6611274	1	Fast nyckel	Spanner	
	6602926	1	Kombinationstång	Combination pliers	
	7000930	1	Kulhammare	Ball hammer	
	795072	1	Hävstångssmörjspruta, kompl.	Grease gun, complete	
	753104	1	. Smörjslang Lubricating hose	
	795074	1	. Kopplingsnippel	. Threaded union	
	705543	1	Svängjärn, komplett	Tommy bar, complete	
	907213	1	. Råffelpinne	. Slotted pin	
	755664	1	Spännbjörn för band	Track-tightening iron	
	755665	1	S-krok	S-hook	
	755666	1	Kätting	Chain	

Grupp Group		T 1		SM 460		 Reservdelskatalog Parts catalogue	
Sida Page		1		Satsförpackningar Packages of Sets			
Pos. Fig.	Det.nr Part No.	Antal Qty	Benämning	Description	Anmärkning Notes		
	754298	1	Packningsats för sotning, komplett	Set of gaskets for decarbonizing the engine, complete			
			. Packning för:	. Gasket for			
	6613335	1	. cylinderlock	. Cylinder head			
	6613154	1	. bakre täckplatta, cylinderlock	. Cover plate, rear /cylinder head/			
	6613054	1	. kylvattenuttag Cooling water outlet			
	6613147	1	. kylvattenuttag, övre	. Cooling water outlet, upper			
	6613166	1	. kylvattenuttag, förbiledning	. Cooling water outlet /by-pass pipe/			
	6613475	2	. avgasrör - cylinderlock	. Exhaust manifold to cylinder head			
	6613373	1	. insugningsrör Inlet manifold			
	6613179	1	. ventilkåpa	. Cylinder head cover			
	6613581	3	. spridare	. Injector			
	754299	1	Packningsats för helrenovering, komplett	Set of gaskets for major overhaul of engine, complete			
	754298	1	. Packningsats för sotning /spec. se ovan/	. Set of gaskets for decarbonizing the engine /for specification, see above/			
			. Packning för: Gasket for			
	6616601	1	. bakre vevaxeltätning	. Rear crankshaft seal			
	6613065	1	. bakre täckplatta för kamaxelhus	. Rear cover plate for camshaft housing			
	6613167	1	. kylvattenintag Cooling water inlet			
	6613085	1	. hus för hydraulpumpdrivning	. Housing for hydraulic pump drive			
	6613156	2	. täckplatta	. Cover plate			
	6613092	1	. inspektionslock	. Inspection door			
	6613025	1	. täckplatta för hydraulpump-hus Cover plate for hydraulic pump body			
	6613184	1	. oljesump	. Oil sump			
	6613142	1	. oljesump, främre	. Oil sump, front			
	6613664	1	. oljesump, bakre	. Oil sump, rear			
	6613060	1	. smörjoljefilter Lubricating oil filter			
	6613081	2	. täckplatta, bakre, vattenpump	. Cover plate, rear /water pump/			
	6613070	1	. insprutningspump	. Fuel injection pump			
	6613176	1	. transmissionshus - cylinder-block	. Timing gear housing to cylinder block			
	6613284	1	. främre transmissionskåpa	. Front cover			
	754619	1	Bromsbeläggsats, komplett	Set of brake facings, complete			
	6617002	8	. Bromsbelägg	. Brake facing			
	6617003	48	. Nit	. Rivet			
	754119	1	Renoveringsats för vattenpump, komplett	Overhaul set for water pump, complete			
	6613048	1	. Axel	. Shaft			
	6613084	1	. Skovelhjul	. Impeller			
	6613981	1	. Tätning	. Seal			

Reservdelskatalog
Parts catalogue



SM 460

Grupp T 1
Group

Sida 2
Page

Satsförpackningar

Packages of Sets

Pos. Fig.	Det.nr Part No.	Antal Qty	Benämning	Description	Anmärkning Notes
	6613064	1	. Avkastarfläns Thrower flange	
	6613081	1	. Packning	. Gasket	
	7348333	1	Lamellbeläggsats, komplett	Set of clutch facings, complete	
	S. E. S.	2	. Lamellbelägg	. Clutch facing	
	952493	42	. Nit Rivet	
	754092	1	Kolvringssats, komplett	Set of piston rings, complete	
	6613075	4	. Kolvring	. Piston ring	
	6613131	1	. Kolvring	. Piston ring	
	6613296	1	. Kolvring, övre Piston ring, upper	
	6613123	1	. Oljering	. Oil ring	
	6613297	1	. Oljering	. Oil ring	